



Rosyth School
Mid-Year Examination 2022
SCIENCE
Primary 4

Name: _____

Total
Marks:

50
56

Class: Pr 4- _____

Register No. _____

Date: 12 May 2022

Total Time for Booklet A and B: 1h 45min

Booklet A

Instructions to Pupils:

1. Please do not turn this page until you are told to do so.
2. Follow all instructions carefully.

* This booklet consists of 20 printed pages (including cover page).

This paper is not to be reproduced in part or whole without the permission of the Principal.

For each question from 1 to 28, four options are given. One of them is the correct answer. Make your choice (1, 2, 3 or 4). **Shade the correct oval (1, 2, 3 or 4) on the Optical Answer Sheet.** (56 marks)

1. Siti observed a plant and recorded her observations of the plant after three weeks.

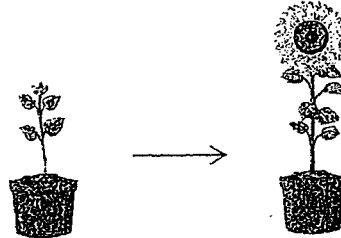

Which of the following characteristics of living things does the plant show?

- (1) Living things can grow.
 - (2) Living things can respond to changes.
 - (3) Living things need air, food and water.
 - (4) Living things can make their own food.
2. Jason conducted an experiment with two slices of bread, X and Y. Bread X was toasted and cooled before being sealed in a plastic bag while a few drops of water was added on Bread Y and sealed it in a similar plastic bag.

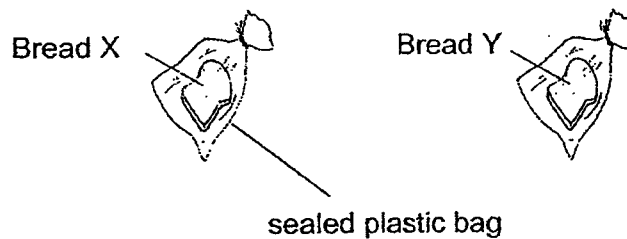

What would Jason most likely observe after a week?

- (1) Mould would appear on Bread X only.
- (2) Mould would appear on Bread Y only.
- (3) Mould would appear on both Bread X and Y.
- (4) No mould would appear on both Bread X and Y.

3. Ali had two sheets of plastic, A and B. He covered two plots of grass patches using the plastic sheets as shown below.

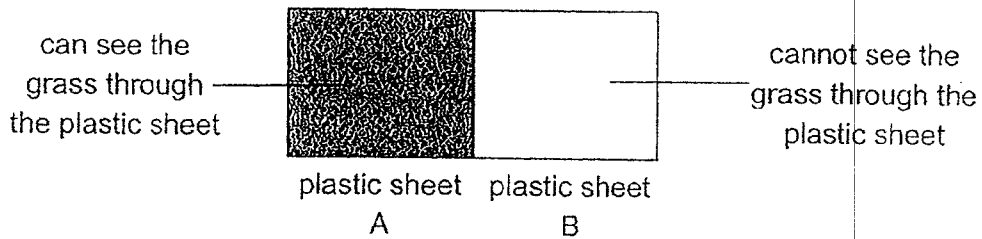

After two weeks, the grass patch below plastic sheet A was green and healthy but the grass patch below plastic sheet B was yellow and wilted.

Which of the following best explains why the grass patch turned yellow and wilted below the plastic sheet B?

- (1) There was not enough air for the grass.
 - (2) There was not enough water for the grass.
 - (3) There was not enough sunlight for the grass.
 - (4) There was not enough nutrients for the grass.
4. The diagram below shows a life cycle of a group of animals.

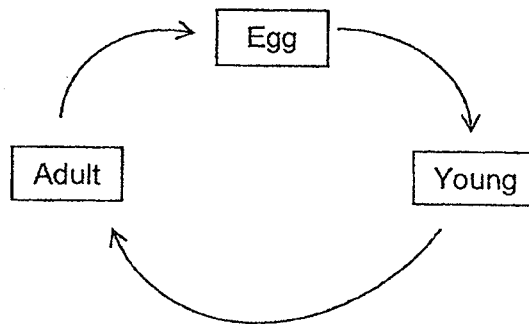

In which group will some animals not have a similar life cycle as the one shown above?

- (1) birds
- (2) insects
- (3) reptiles
- (4) amphibians

5. The diagram below shows the young of an animal.



Which of the following diagrams shows the next stage of its development?

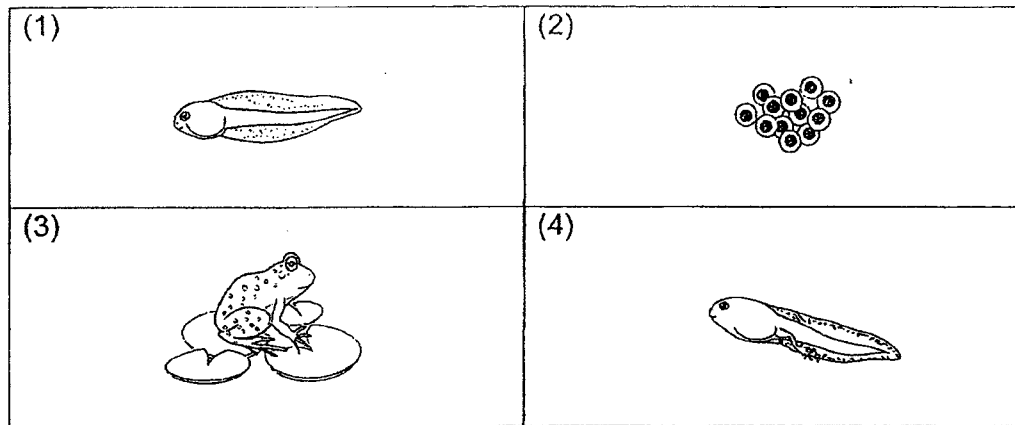

6. Which of the following statements correctly explains how a young plant is different from an adult plant?

The adult plant _____ but the young plant does not.

- (1) has roots
- (2) needs air
- (3) needs water
- (4) bears flowers

7. The diagram below shows the different stages in the life cycle of a cockroach.



Which of the following shows the correct life cycle of a cockroach?

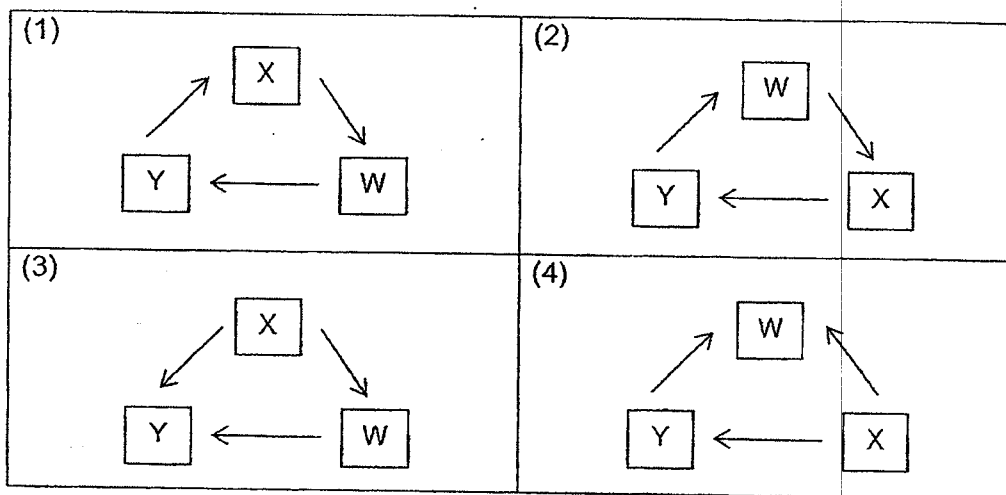

8. Susan made some statements about the differences between the adult grasshopper and its nymph.

- A: The adult is small while the nymph is big.
- B: The adult can reproduce while the nymph cannot.
- C: The adult has wings while the nymph does not.
- D: The adult needs food while the nymph does not.

Which of the above statements are correct?

- (1) A and B only
- (2) A and D only
- (3) B and C only
- (4) C and D only

9. The table below gives some information about the life cycles of four animals, S, T, U and V.

Questions	S	T	U	V
Does the young look like its adult?	No	Yes	No	Yes
Does it have a four-stage life cycle?	No	No	Yes	No
Does it reproduce by laying eggs?	Yes	No	Yes	Yes

Which animal, S, T, U or V, most likely represents a chicken?

- (1) S
- (2) T
- (3) U
- (4) V

Study the picture below to answer questions 10 and 11.

The picture below shows a germinating seed with its parts, W, X, Y and Z.

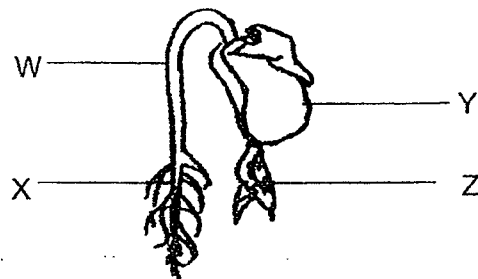

10. Which part of the seed grows first during germination?

- (1) W
- (2) X
- (3) Y
- (4) Z

11. What is the function of part Y?

- (1) It gives the seedling support.
- (2) It makes food for the seedling.
- (3) It provides food for the seedling.
- (4) It provides warmth for the seedling.

12. Muthu wanted to study which type of plant, X or Y, grows better on top of a moving bus.

Which of the following set-ups should he use?

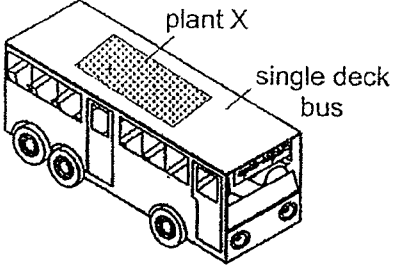
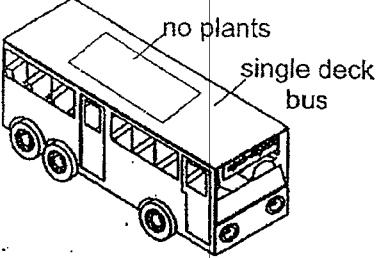
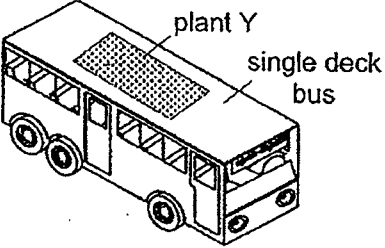
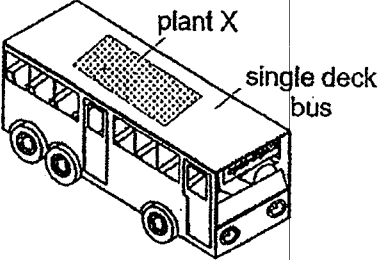
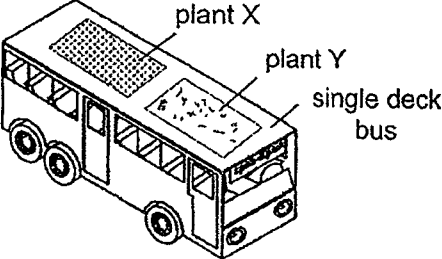
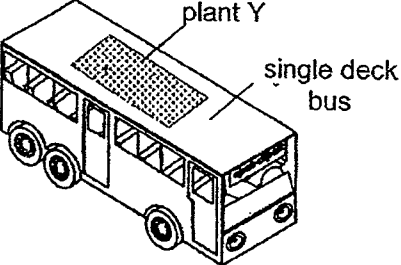
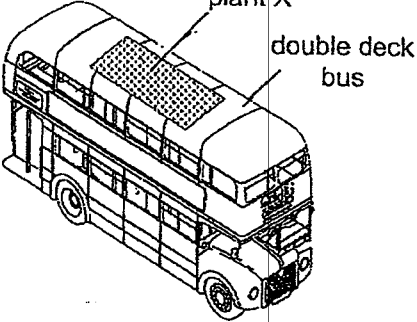
Set-ups	
(1)	 
(2)	 
(3)	
(4)	 

13. Mimi observed the changes that a plant had gone through over several months. She made a drawing of the changes as shown in the diagram below.



Based on her observations, Mimi made wrote some statements about the plant. Which of her statement is correct?

- (1) The plant is a non-flowering plant.
 - (2) The young resembles the adult plant.
 - (3) The plant's life cycle begins with a spore.
 - (4) There are six stages in the plant's life cycle.
14. A rubber balloon was inflated and twisted in such that it looked like a stalk of flower.

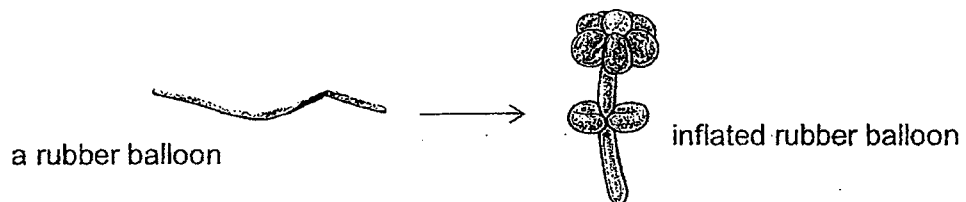

What property of the rubber balloon is shown above?

- (1) Strength
- (2) Flexibility
- (3) Waterproof
- (4) Able to float on water

15. Mrs Tan wanted to find the volume of different objects, W, X, Y and Z. Each object had to be gently lowered into the water with a string attached as shown below. The change in the water level is then being observed.

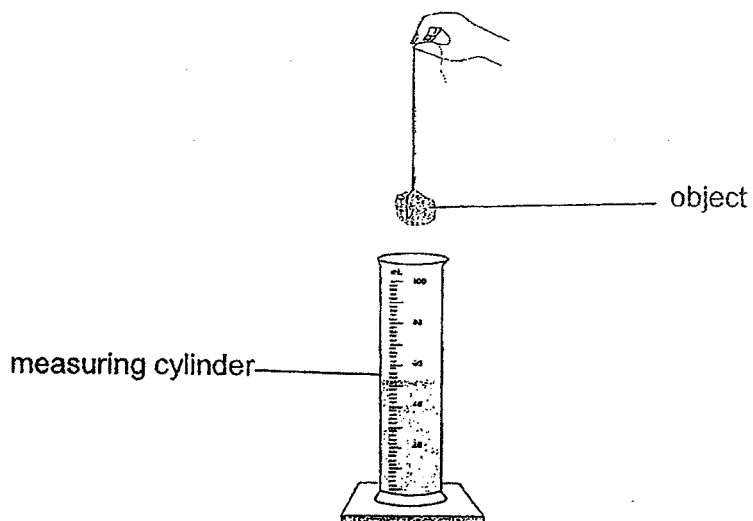

The table below shows the properties of four objects, W, X, Y and Z.

Object	Does it float on water?	Is it waterproof?
W	Yes	No
X	No	No
Y	No	Yes
Z	Yes	Yes

Which of the objects, W, X, Y and Z can Mrs Tan measure its volume using the above method?

- (1) W
- (2) X
- (3) Y
- (4) Z

16. Look at the pictures below. Which of the following is a source of light?

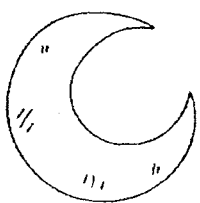
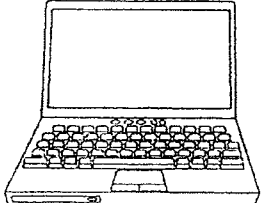
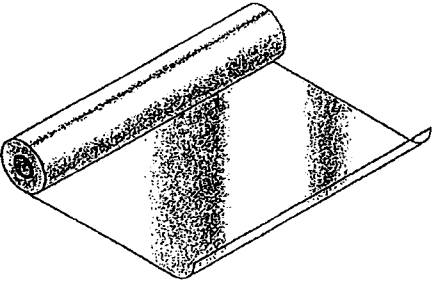
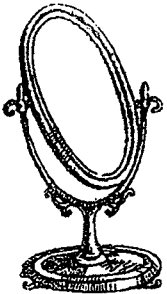
<p>(1) The moon</p> 	<p>(2) A laptop with screen on</p> 
<p>(3) A roll of aluminium foil</p> 	<p>(4) A mirror</p> 

17. Philip can read his book under the lighted lamp. Which of the following shows correctly the path of light so that Philip can see the book?

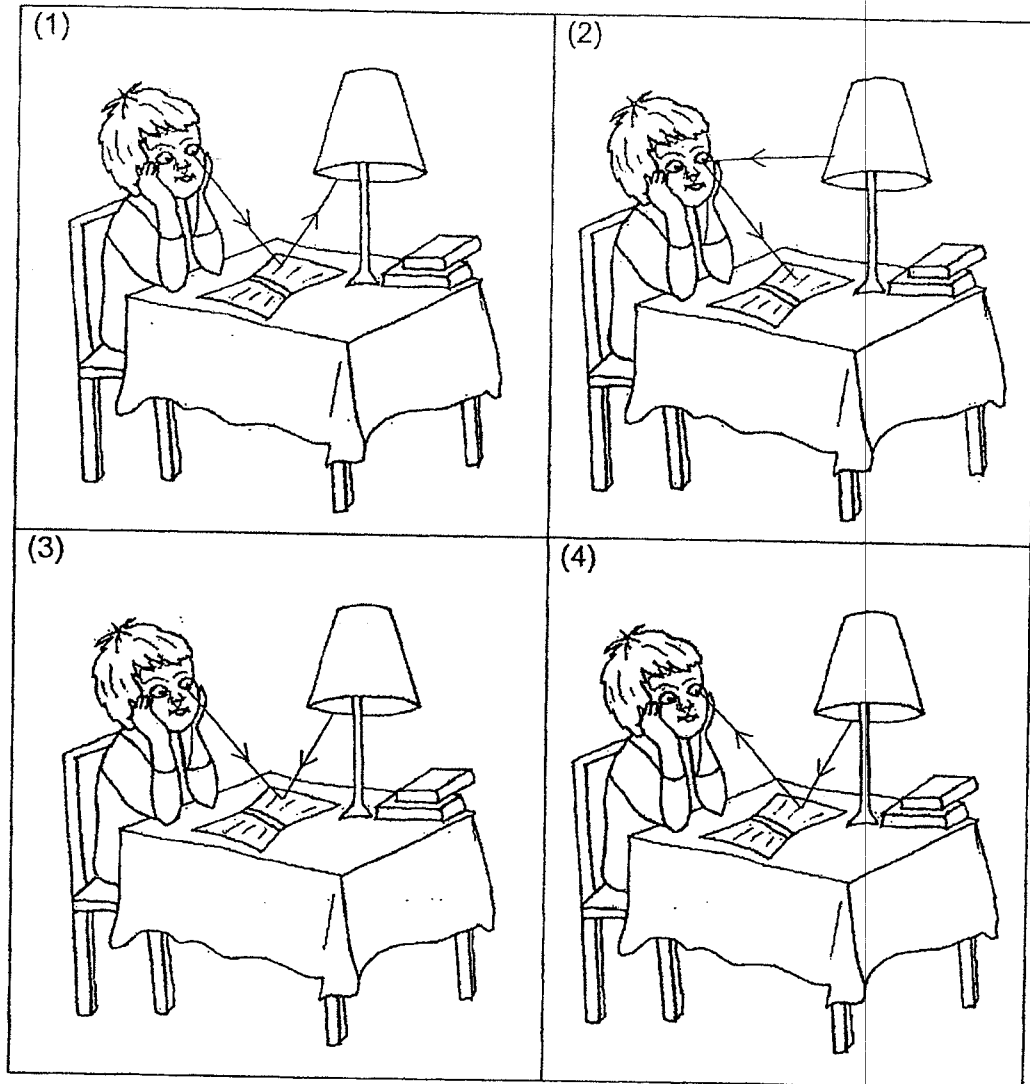

18. Andrew set up an experiment as shown below.

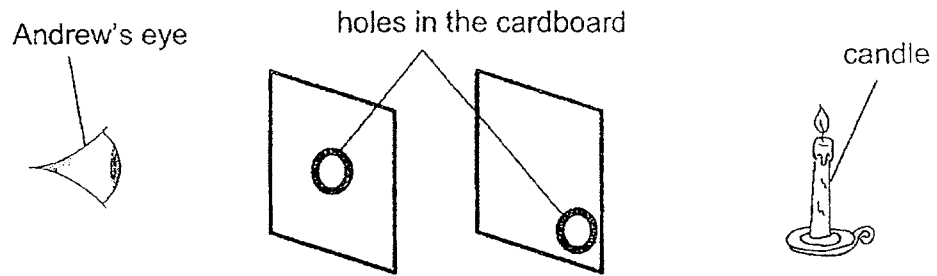

Andrew could not see the lighted candle.

Which property of light can he conclude from his experiment?

- (1) Light can be reflected.
- (2) Light travels in all directions.
- (3) Light travels in a straight line.
- (4) Light can pass through some materials.

19. Annie placed two identical wooden cylinders in different positions in a dark room with torches shining at them as shown in the diagram below. Shadows were formed on screens, S and T.

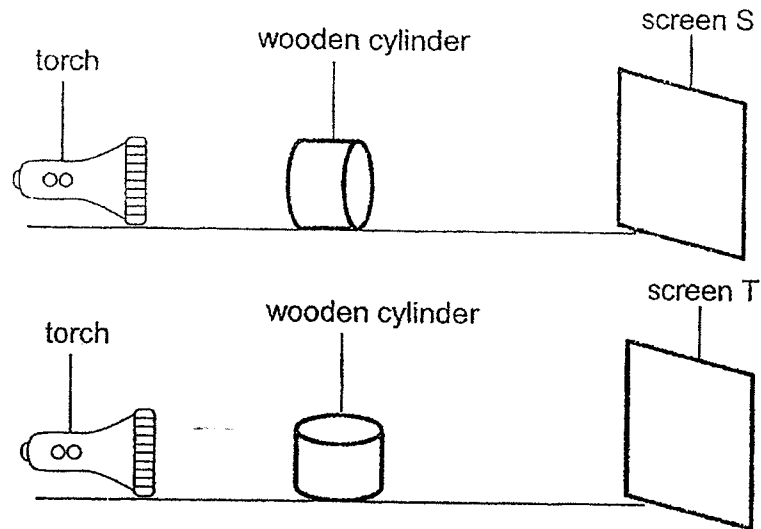

Which of the following shadows would Annie observe on screens, S and T?

	Screen S	Screen T
(1)		
(2)		
(3)		
(4)		

20. Kai Ting placed three shapes, W, Y and Z, of equal height at different distances in front of a torch as shown below. The shapes are hollow in the centre.

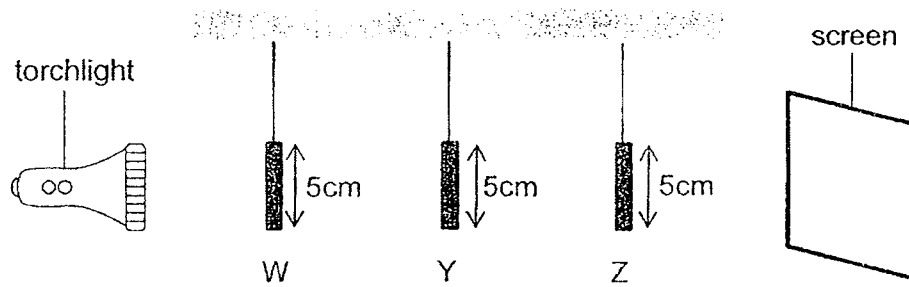

The diagram below shows the shadows that were seen on the screen.

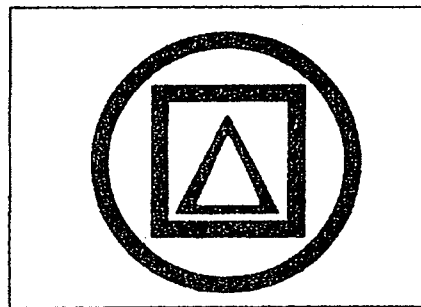

Which of the following correctly represents shapes, W, Y and Z?

	W	Y	Z
(1)	triangle	square	circle
(2)	triangle	circle	square
(3)	circle	square	triangle
(4)	circle	triangle	square

21. Shamady walked in a straight line from points A to C. The distance between point A and B is the same as the distance between points B and C. There was a ceiling lamp hanging directly above point B.

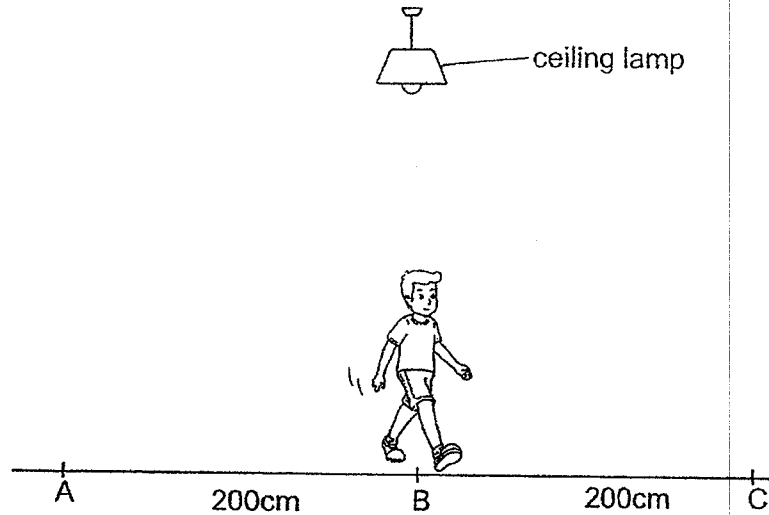

Based on the diagram above, which one of the following bar graphs best shows the length of Shamady's shadow at points, A, B and C?

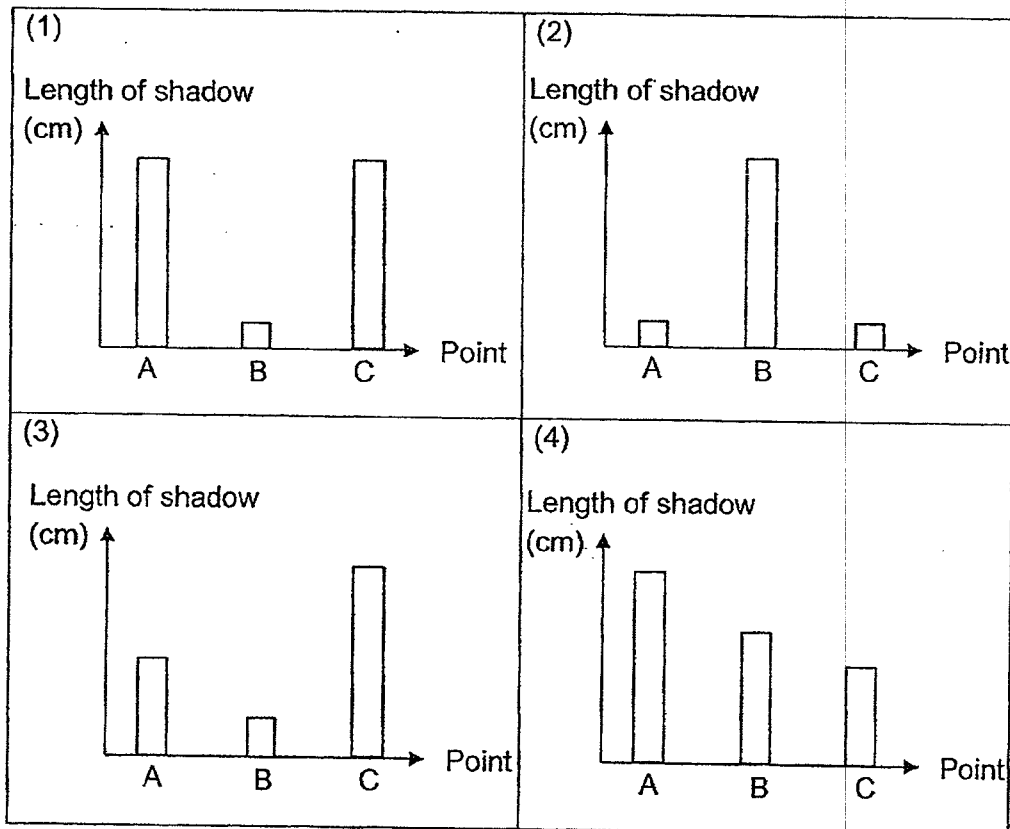

22. Mary wanted to find out how different materials affect the amount of light passing through them using the set-up shown. She conducted the experiment in a dark room.

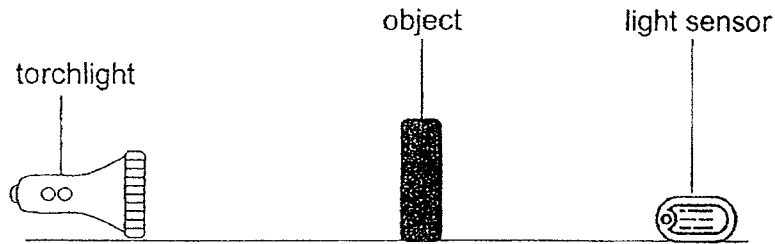

Which of the following variables should be changed for her investigation?

- (1) The shape of the object
- (2) The height of the object
- (3) The material of the object
- (4) The distance between the torch and the light sensor

23. Shirley set up an experiment in a dark room using a torch and four sheets made of different materials, A, B, C and D. One of the sheets had a hole cut out from it.

The properties of the four sheets of materials are shown in the table below.

Property of Materials	Material
Allows light to pass through	A, B
Does not allow light to pass through	C, D

Shirley arranged the sheets as shown below.

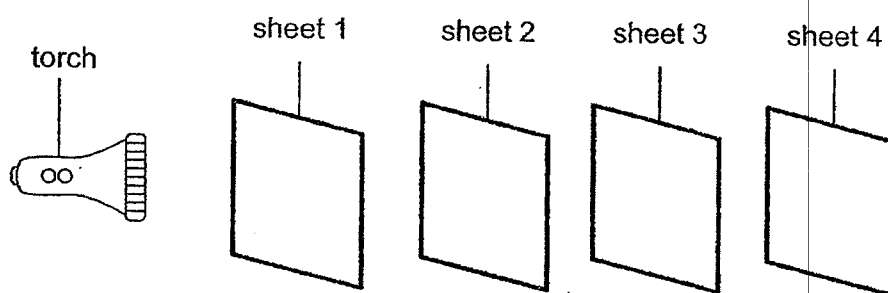

How would Shirley arrange the sheets if she wanted a bright circular patch of light to appear on sheet 3 as shown above?

	sheet 1	sheet 2	sheet 3	sheet 4
(1)	A	B	C	D
(2)	A	D	B	C
(3)	C	A	D	B
(4)	C	A	B	D

24. The diagram below shows a sleeping mouse hidden within two boxes. Both the boxes have holes labelled A, B, C, D, E, F, G and H, at different sides.

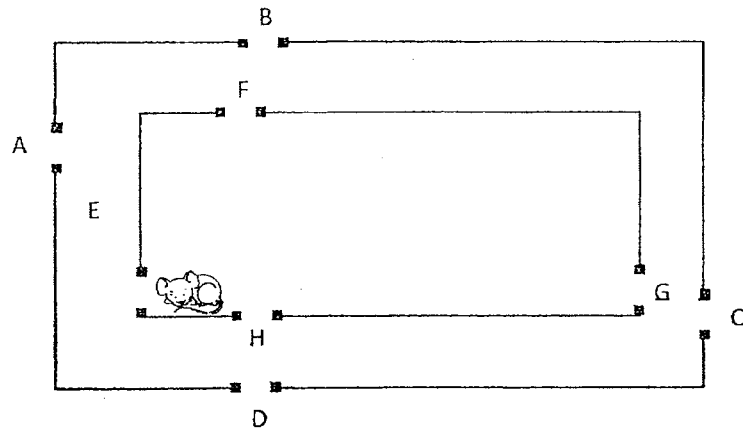

Which hole should you shine light through if you want to see the sleeping mouse in the box?

- (1) A
 - (2) B
 - (3) C
 - (4) D
25. Four students each made a statement for matter as shown below.



Hafiq

Air is not a matter as it cannot be seen.



Susan

All matter can be seen.



Yi Xin

Water is a matter as it has mass and occupies space.



Peter

Air is not a matter as it does not occupy space.

Which student has described matter correctly?

- (1) Hafiq
- (2) Susan
- (3) Yi Xin
- (4) Peter

26. Jaslyn wants to measure the mass of a marble as shown below.



Which of the following apparatus should she use?

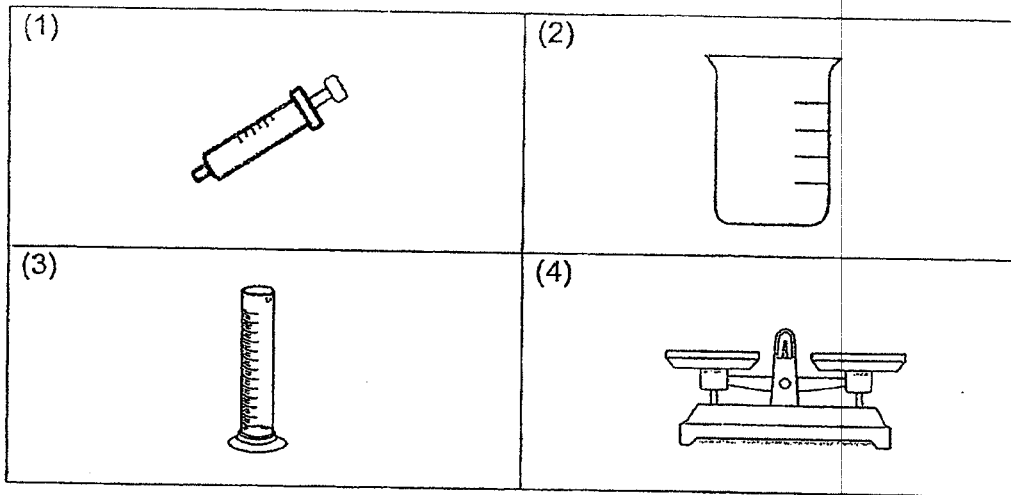

27. Which of the following is **not** a matter?

- (1) Music
- (2) Cotton
- (3) Smoke
- (4) Television

28. A crow came upon a tall and heavy container that has some water at the bottom of it.

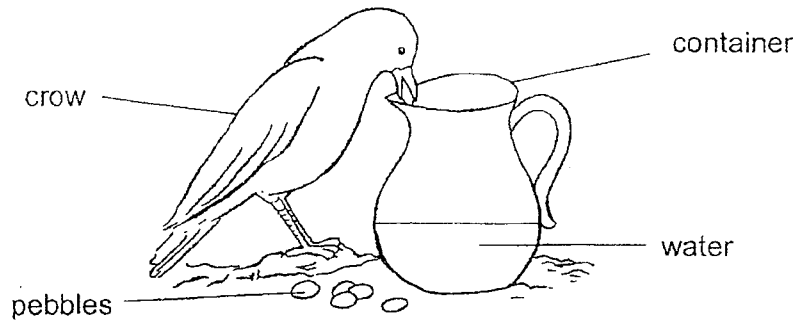

The crow could not drink the water. It started dropping pebbles into the container. After dropping in about twenty pebbles, the crow was finally able to drink the water from the container as the water level increased.

What property of the pebbles caused the water level to increase?

- (1) The pebbles have mass.
- (2) The pebbles absorb water.
- (3) The pebbles take up space.
- (4) The pebbles does not allow light to pass through.

(Go to Booklet B)



Rosyth School
Mid-Year Examination 2022
SCIENCE
Primary 4

83½

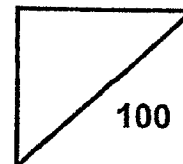

Name: _____

Total
Marks:

Class: Pr 4- _____ Register No. _____

Date: 12 May 2022

Parent's Signature: _____

Duration: Total time for Booklets A and B: 1 h 45min

Booklet B

Instructions to Pupils:

1. Please do not turn this page until you are told to do so.
2. Follow all instructions carefully.
3. Answer all questions.

	Maximum	Marks Obtained	
Booklet A	56 marks		
Booklet B	44 marks		
Total	100 marks		

* This booklet consists of 16 printed pages (including cover page).

This paper is not to be reproduced in part or whole without the permission of the Principal.

For questions 29 to 40, write your answers in this booklet.

(44 marks)

29. May saw a bird eating some food crumbs on the floor. She ran over and the bird flew away.

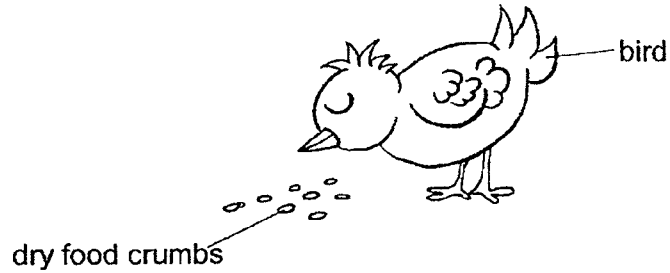

Fill in the table below with correct characteristics of living things that matches the actions of the bird. [2]

Actions of the bird	Characteristics of living things
The bird was eating the food crumbs on the floor.	(a)
The bird flew away as May ran towards it.	(b)

30. Jackson created a classification chart as shown below.

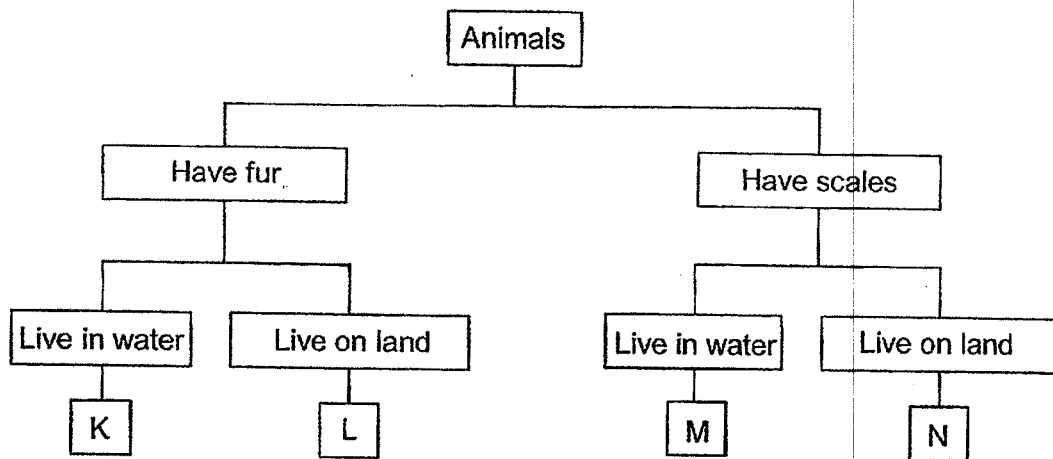

(a) Which letter, K, L, M or N best represents each of the following animals? Write your answers in the boxes provided. [1]

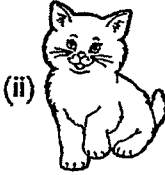
(i)  (ii) 

house lizard

cat

(b) Based on the classification chart above, state all the characteristics of animal M. [1]

(c) Jackson claimed that animal K is a mammal. Do you agree with him? Explain your answer. [2]

31. Jason placed two caterpillars in a glass tank with some leaves and a stick. He covered the tank with some wire mesh as shown in the diagram below.

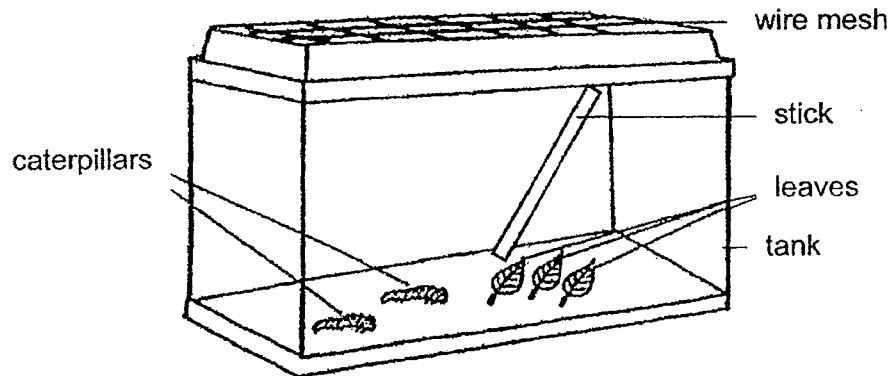

- (a) Why did he place leaves in the tank? [1]

- (b) Why did he use a wire mesh to cover the tank instead of a glass cover? [1]

- (c) After a week, Jason saw that one caterpillar had developed into the next stage of its life cycle as shown below.

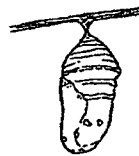

- What stage of the life cycle is shown above? [1]

- (d) State one difference between the caterpillar and the stage observed in (c) in terms of the amount of food eaten. [1]

32. Mariam measured how long it took for the different stages of a beetle to develop. She then plotted her results in the graph shown below.

(a) Help Mariam to complete her graph by labelling the empty boxes with “Stages” and “Number of days” correctly. [2]

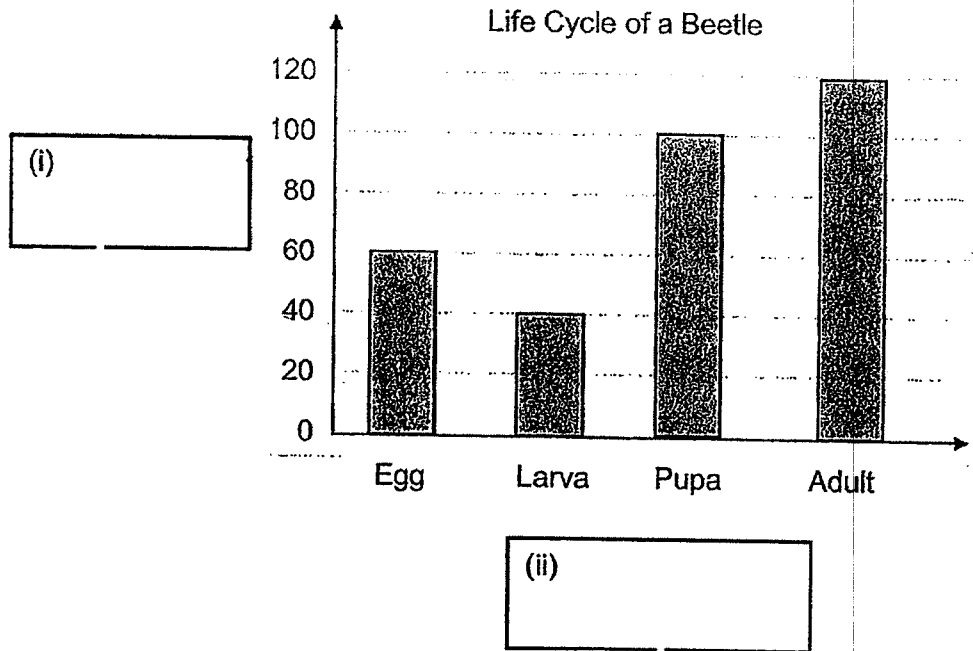

(b) How many days would it take for the young to become an adult beetle after the egg had hatched? [1]

33. Study the classification chart shown below.

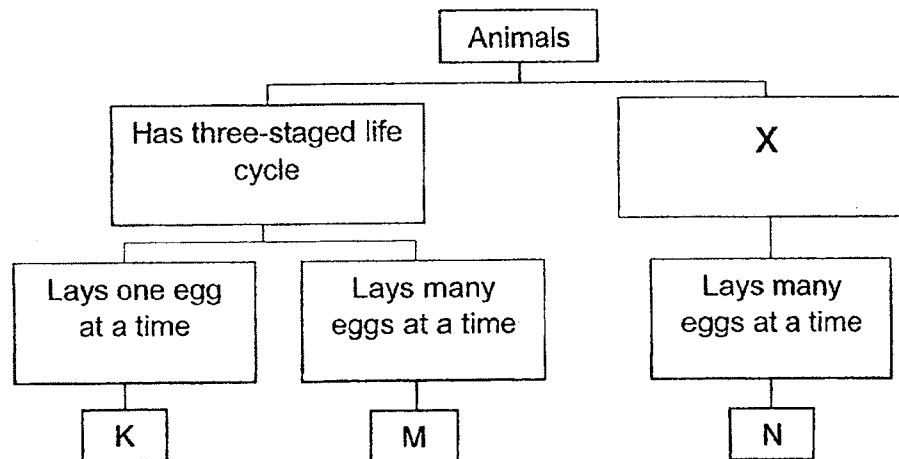

(a) Based on the classification chart above, what is a possible heading for the box marked "X"? [1]

(b) A grasshopper lays eggs in a pod. Below is a diagram of the eggs in a pod.

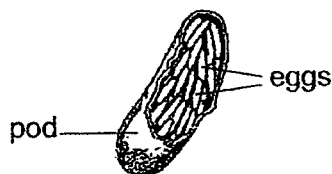

Based on the diagram above, in which group, K, M or N, would you classify grasshopper? Explain your choice. [1]

(c) Why do animals in group M and N lay many eggs at a time? [1]

34. The diagram below shows the life cycle of a mosquito.

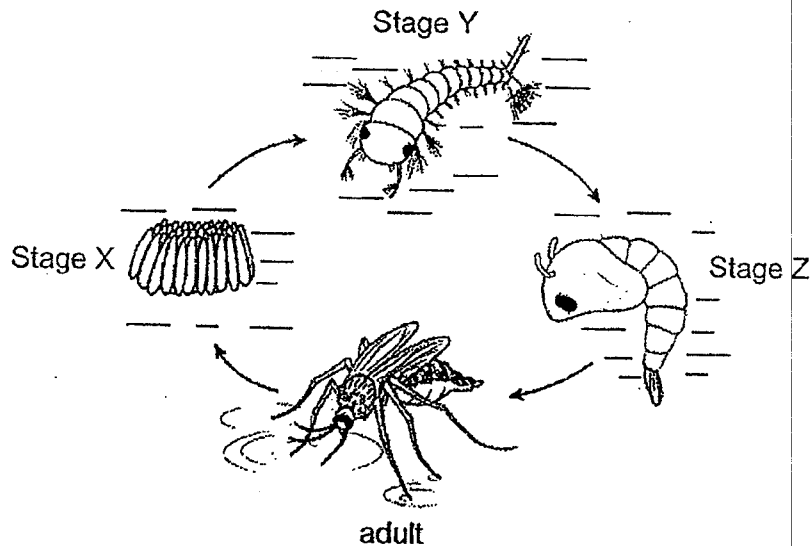

(a) Identify Stage X and Stage Z. [1]

(i) Stage X: _____

(ii) Stage Z: _____

(b) One way to reduce the number of mosquitoes is to pour a layer of oil on the surface of the water.

Explain why this method can be used to reduce the number of mosquitoes. [1]

(c) The table below shows the effect of temperature on the average time taken for a mosquito to hatch from an egg and develop into an adult.

Temperature (°C)	Average length of the life cycle of a mosquito (days)
16	42
21	25
27	14
32	12

At which temperature will there be an increase in the number of mosquitoes. Explain why. [2]

35. Study the two set-ups, A and B, as shown below.



Set-up A
Planted in soil
Watered daily



Set-up B
Planted in soil
Not watered at all

(a) Based on the observation above, put a tick [✓] to identify the variables that should be kept the same. [1]

	Type of Variables	Tick [✓] if it should be kept the same
(i)	Type of bean	
(ii)	Type of soil	
(iii)	Volume of water	
(iv)	Amount of light	

(b) Only the bean in set-up A germinated. What can be concluded from this experiment? [1]

(c) State two other conditions needed for a bean to germinate. [1]

Q35 is continued on the next page

- (d) The bean in set-up A continued to grow into a young plant as shown below.

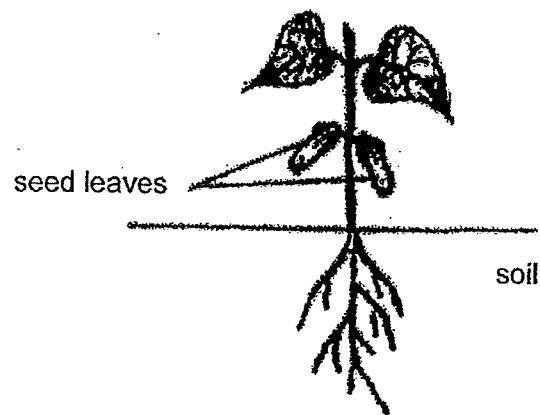

Meiling then removed the seed leaves and the plant was left in the garden for another week. After one week, it was observed that the plant continued to grow and increase in height.

Explain why the plant continued to survive even though the seed leaves were removed.

[1]

36. Eileen conducted an experiment to find out the volume of water that could pass through materials, W, X, Y and Z.

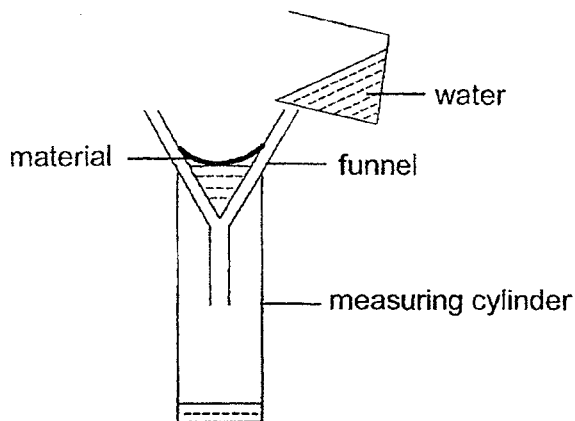

She poured 300ml of water over material W and measured the volume of water collected in the measuring cylinder after 5 minutes. She repeated the experiment with materials, X, Y and Z. She then recorded her results as shown below.

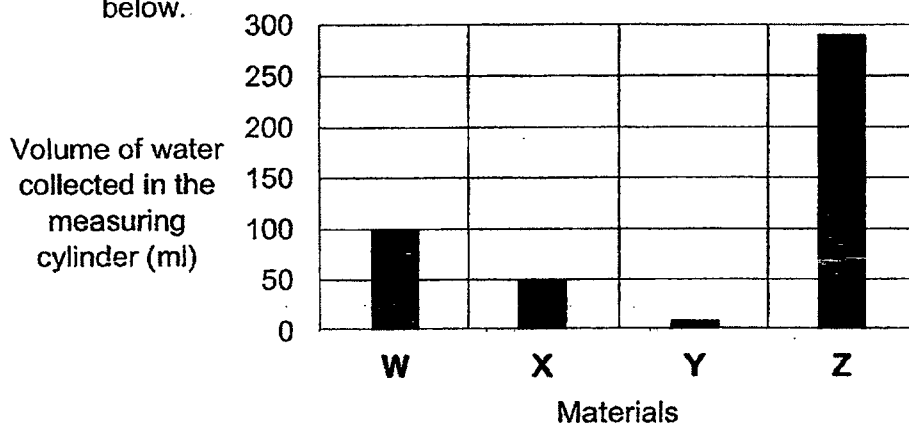

- (a) Using the bar graph above, record the volume of water collected in the measuring cylinder for material X.

[1]

Materials	Volume of water collected in the measuring cylinder (ml)
W	100
X	(a) <input type="text"/>
Y	10
Z	290

Q36 is continued on the next page

- (b) Eileen then repeated the experiment by increasing the thickness of material W. What would happen to the volume of water collected in the measuring cylinder for material W? [1]

- (c) The picture below shows a rag used for cleaning wet surfaces.

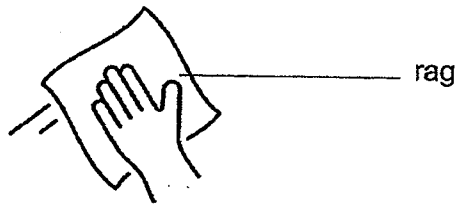

Based on the results given, which material W, X, Y or Z, is most suitable for making such a rag? Explain your answer. [2]

37. In a dark room, Elaine set up the following experiment with three different liquids, A, B and C, in identical beakers.

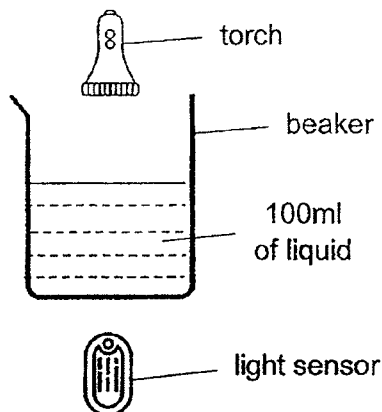

She switched on the torch and used a light sensor to measure the amount of light that passed through each liquid. She recorded the data in the table below.

Liquid	Amount of light that passed through each liquid (unit)
A	200
B	0
C	80

- (a) Based on the results above, match liquids, A, B and C, correctly to the given liquids. [3]

- Liquid A • Chocolate Milk
- Liquid B • Apple Juice
- Liquid C • Water

- (b) Give a reason why the experiment was conducted in a dark room. [1]

38. Kai Hui conducted an experiment using a torch, a wooden box and a screen in a dark room as shown below.

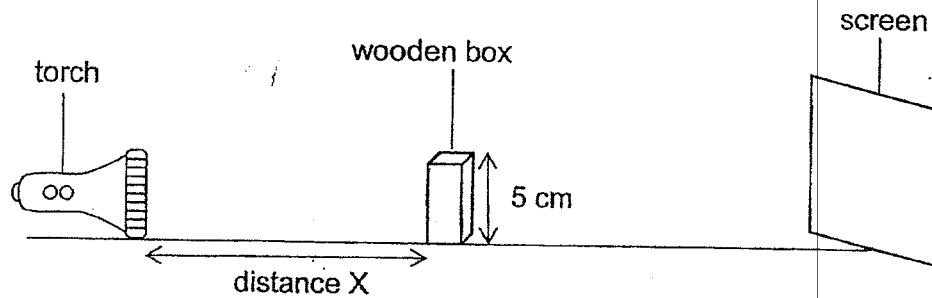

She moved the wooden box to find out if distance X affects the height of the shadow formed on the screen. Her findings were recorded in the table below.

Distance X (cm)	Height of the shadow formed on the screen (cm)
20	32
30	24
40	16
50	8

- (a) Name one property of the screen so that a dark shadow could be formed on the screen. [1]
- _____
- (b) Explain how the wooden box formed a dark shadow on the screen. [1]
- _____
- _____
- (c) What could she do if she wanted to form a bigger shadow on the screen when distance X was kept at 20cm? [1]
- _____
- _____
- (d) Based on the findings, what is the relationship between distance X and the height of the shadow formed on the screen? [1]
- _____
- _____

39. Mary wanted to find out if the volume of an object will affect the mass of the object. Her set-up is as shown below.

120cm³ of sponge

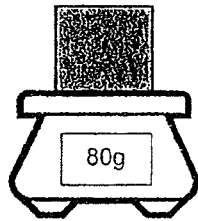

Apparatus X

40cm³ of steel block

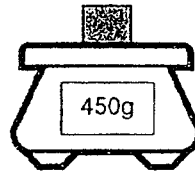

80cm³ of wooden block

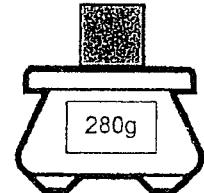

- (a) Name apparatus X. [1]

- (b) Using the set-up above, was it a fair test? Give a reason for your answer. [1]

Mary then conducted another experiment as shown below. She weighed three wooden blocks of different sizes and measured their masses.

20cm³ of wooden block

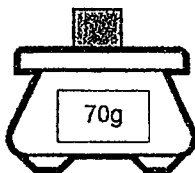

Apparatus X

40cm³ of wooden block

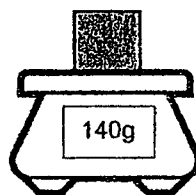

60cm³ of wooden block

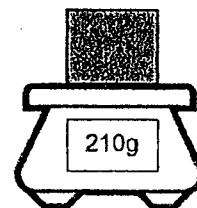

- (c) Put a tick (✓) in the box to identify the aim of the experiment. [1]

- To find out how the mass of an object affects its volume.
- To find out how the volume of an object affects its mass
- To find out how the material of an object affects its mass.

- (d) Predict the mass of the 30cm³ of block made of similar wood as above. [1]

40. Study the diagram below.



Study the flowchart below.

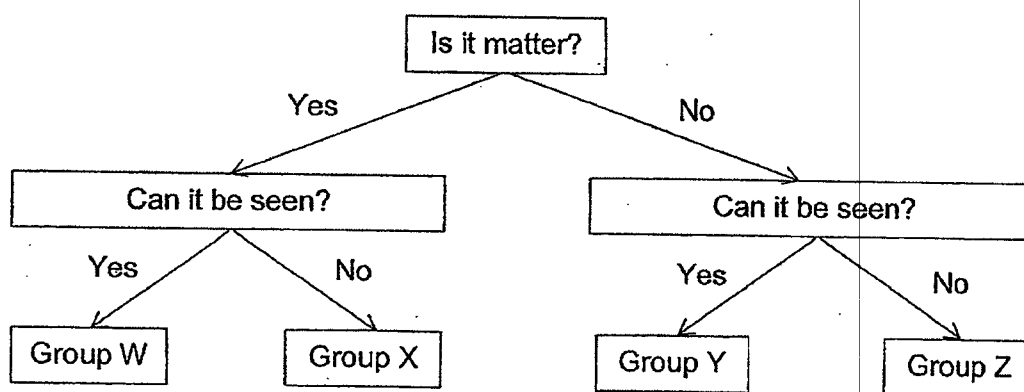

(a) In which group W, X, Y and Z, would the following parts be classified in the flowchart? [2]

Part	Group
hot air	
candle stick	

Q40 is continued on next page

- (b) Based on the flowchart, explain why a dog is in group W but the shadow it casts is in group Y. [2]

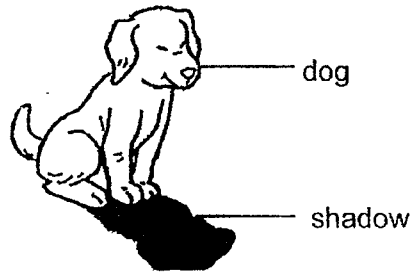

End of Paper

SCHOOL : ROSYTH PRIMARY SCHOOL
 LEVEL : PRIMARY 4
 SUBJECT : SCIENCE
 TERM : 2022 SA1

SECTION A

Q 1	Q2	Q3	Q4	Q5	Q6	Q7	Q8	Q9	Q10
1	2	3	2	3	4	2	3	4	4
Q 11	Q12	Q13	Q14	Q15	Q16	Q17	Q18	Q19	Q20
3	3	2	2	3	2	4	3	3	3
Q 21	Q22	Q23	Q24	Q25	Q26	Q27	Q28		
1	3	3	2	3	4	1	3		

Section B

Q29)	a) Living things need food to survive b) Living things responds to change
Q30)	a) I) N ii) L b) Animal M has scales and lives in water. c) Yes as Animal K has fur and only mammals have fur.
Q31)	a) He placed leaves in the tank for the caterpillars to eat. b) He used a wire mesh instead of a glass cover as the wire mesh allows air to enter the tank and animals need air to survive. c) Pupa d) The larva eats a lot of food but the pupa does not
Q32)	a) I) Number of days ii) stages b) It would take 140 days
Q33)	a) Has four-staged life cycle b) M as grasshopper has three-staged life cycle and also lay many eggs at a time c) To ensure that there will be a higher chance to survive.

Q34)	<p>a) i) egg ii) pupa</p> <p>b) The layer of oil on the surface of the water will block the air from entering into the water and thus larva does not have air to breathe and will not survive long.</p> <p>c) 16° as the average length of the life cycle of a mosquito is longest and thus have higher chance to breed more often.</p>
Q35)	<p>a) Tick "Type of bean", "Type of soil" and "Amount of light"</p> <p>b) Seeds need water to germinate</p> <p>c) warmth and air</p> <p>d) The leave can make food for the plant.</p>
Q36)	<p>a) 50</p> <p>b) It will become lesser.</p> <p>c) Y as only 10 ml of water can pass through so it can absorb mos of the water.</p>
Q37)	<p>a) Liquid A → water; Liquid B → Chocolate Milk; Liquid C → Apple Juice</p> <p>b) So that the amount of light captured by the light sensor is only coming from the torch and not the surrounding</p>
Q38)	<p>a) It is opaque</p> <p>b) It is opaque and no light can pass through it</p> <p>c) Move the screen farther away</p> <p>d) The smaller the distance X, the height of the shadow is taller/larger.</p>
Q39)	<p>a) Weighing scale</p> <p>b) Not a fair test because there should be only one changed variable (i.e. the volume of the object) and the material of the object must be the same.</p> <p>c) To find out how the volume of an object affects its mass</p> <p>d) 105 g</p>
Q40)	<p>a) Hot air → X ; candle stick → W</p> <p>b) The dog is a matter and can be seen but the shadow is not a matter yet can be seen</p>